



Westinghouse

**USER'S MANUAL**  
*MANUEL DE L'UTILISATEUR*  
*MANUAL DEL USUARIO*

---

**SK-40H590D**

Widescreen DVD Combo

*Combo Lecteur à Écran Géant*

*Combo DVD Pantalla Grande*

# TABLE OF CONTENTS

English

Español

Français

<b>IMPORTANT SAFETY AND PRECAUTIONS .....</b>	<b>1</b>
Important Information.....	1
Safety Precautions.....	2
Important Safety Instructions.....	4
<b>GENERAL INFORMATION .....</b>	<b>6</b>
Feature.....	6
Controls and Ports of the Panel.....	7
Accessories .....	9
Remote Control.....	10
<b>INSTALLATION AND FUNCTION ADJUSTMENT .....</b>	<b>12</b>
Installation.....	12
How to remove the BASE.....	15
Function adjustment .....	16
<b>TROUBLESHOOTING .....</b>	<b>31</b>
<b>PC INPUT PRESET TIMMING TABLE.....</b>	<b>34</b>
<b>PRODUCT SPECIFICATION .....</b>	<b>35</b>



# IMPORTANT SAFETY AND PRECAUTIONS

This wide active matrix TFT (thin film transistor) liquid crystal monitor is designed for use as a stand alone TV as well as a display device for video electronics appliances and personal computers.

## **Important Information**

Warning : To reduce the risk of fire or electric shock, do not expose this product to rain or moisture.

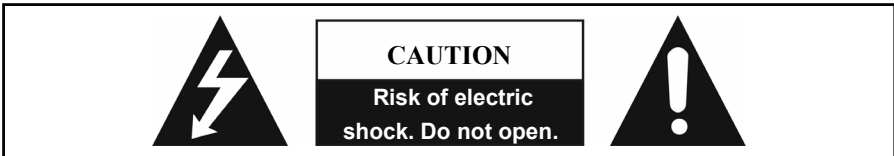

Caution :To reduce the risk of electric shock, do not attempt to disassemble or modify this device. There are no user-serviceable parts inside. Refer any service issues to qualified service personnel.

Caution : FCC/ CSA regulations state that any unauthorized changes or modifications to this equipment may void the user's authority to operate it.

Important: One Federal Court has held that unauthorized recording of copyrighted TV programs is an infringement of U.S. copyright laws. Certain Canadian programs may also be copyrighted and any unauthorized recording in whole or in part may be in violation of these rights.

Warning : Do not leave stationary images, patterns, PIP windows, or letterbox images on the screen for prolonged periods of time as this may result in permanent damage to the LCD panel. This type of damage is not covered under warranty. The following are examples of, but not limited to, potentially hazardous display output: side bar images, video game patterns, closed captioning, channel logos and letterbox black bars. To prevent this type of damage, it is recommended to display constantly moving images that fill the screen as often as possible.

According to industrial standards for LCD display technology; there are a certain number of allowable defective pixels. Although we produce panels with more than 99.9% active cells, there still may be some cells that do not produce light or remain constantly lit. For further information, please contact sales or technical support.

## **Safety Precautions**

1. Cleaning : Unplug the power cord from the AC outlet before cleaning the product. Use a damp cloth to clean the product. Do not use liquid cleaners or aerosol cleaners.
2. Water and moisture : Do not use the product near water or areas of high moisture content such as swimming pools, bathtubs or wet basements.
3. Ensure that no water droplets remain on the screen. Water can cause permanent discoloration.
4. Heat sources : Keep the product away from heat sources such as radiators, heaters, stoves and other heat-generating products (including amplifiers).
5. For added protection during a lightning storm or for extended periods of non-use, unplug the power cord from the wall outlet and disconnect the antenna (if used). This will prevent damage to the product due to power line surges.
6. If an outside antenna is connected to the product, make sure the antenna is properly grounded so as to provide some protection against voltage surges. ( Coaxial connector shielding from cable distribution system should be probably earthed. )

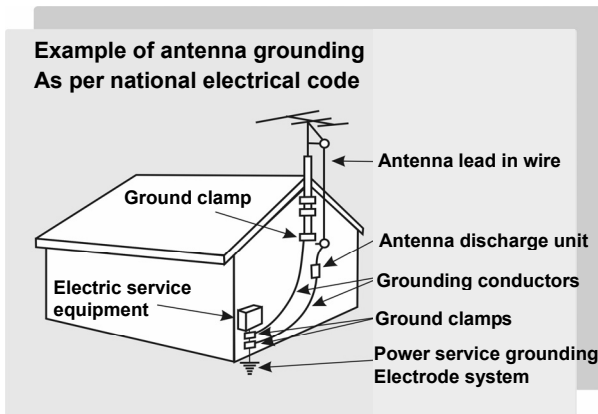

7. Stand : Do not place the product on an unstable cart, stand, tripod or table. Placing the product on an unstable base can cause the product to fall, resulting in serious personal injuries as well as damage to the product. Use only a cart, stand, tripod, bracket or table recommended by the manufacturer or sold with the product. Use only mounting hardware recommended by the manufacturer.



8. Use care when moving the product on a rolling cart. Sudden stops, excessive force and uneven floor surface can cause the product to fall from the cart.

9. Ventilation : The vents and other openings in the cabinet are designed for ventilation. Do not cover or block these vents and openings as insufficient ventilation can cause overheating and/or shorten the life of the product. Do not place the product on a bed, sofa, rug or other similar surfaces since they can block ventilation openings. This product was not designed to operate in an enclosed environment. Don't place the product in an enclosed space such as a bookcase or rack, unless proper ventilation is provided or the manufacturer's instructions are followed.

10. The LCD panel used in this product is made of glass. Therefore, it can break if the product is dropped or struck.

11. During the LCD panel lifespan it is normal for a few pixels to become defective. Non-active pixels may appear on the screen as fixed points of red, blue or green. Refer pixel policy questions to the reseller for further clarification on acceptable loss.

12. An outside antenna system should not be located in the vicinity of overhead power lines or other electrical conduits. When installing an outside antenna, use extreme caution to prevent the antenna from coming into contact with said items, as contact with them may be fatal.

## **Important Safety Instructions**

1. Read these instructions.
2. Keep these instructions.
3. Heed all warnings.
4. Follow all instructions.
5. Do not use this apparatus near water.
6. Clean only with dry cloth.
7. Do not block any ventilation openings. Install in accordance with the manufacturer's instructions.
8. Do not install near any heat sources such as radiators, heat registers, stoves, or other apparatus (including amplifiers) that product heat.
9. Do not defeat the safety purpose of the polarized or grounding-type plug. A polarized plug has two blades with one wider than the other. A grounding type plug has two blades and a third grounding prong. The wide blade or the third prong are provided by your safety. If the provided plug does not fit into your outlet, consult an electrician for replacement of the obsolete outlet.
10. Protect the power cord from being walked on or pinched particularly at plugs, convenience receptacles, and the point where they exit from the apparatus.
11. Only use attachments/accessories specified by the manufacturer.
12. Use only with the cart, stand, tripod, bracket, or table specified by the manufacturer, or sold with the apparatus. When a cart is used, use caution when moving the cart/apparatus combination to avoid injury from tip-over.



13. Unplug the apparatus during lightening storms or when unused for long periods of time.

14. Refer all servicing to qualified service personnel. Servicing is required when the apparatus has been damaged in an way, such as power-supply cord is damaged, liquid has been spilled or objects have fallen into apparatus, the apparatus has been exposed to rain or moisture, does not operate normally, or has dropped.



## GENERAL INFORMATION

### **Feature**

Your TV is designed with the latest technology and is a high-performance unit that includes the following special feature :

- ◆ Multi-sources input included RF IN, D-SUB, HDMIx2, Compositex2, S-Videox2, and Componentx2.
- ◆ Built-in combo tuner is able to receive ATSC, NTSC and Clear QAM Cable signals.
- ◆ Built-in 15W dual channel speakers.
- ◆ Embedded video enhance and noise Reduction features for the colorful and clearest picture possible.
- ◆ Provided multi-channel sound decoder for stereo and bilingual broadcasts.
- ◆ Automatic sleep timer control.
- ◆ Component video input for high definition TV programming (HDTV ready), resolution up to 720p, 1080i.

## Controls and Ports of the Panel

### Front Panel Views

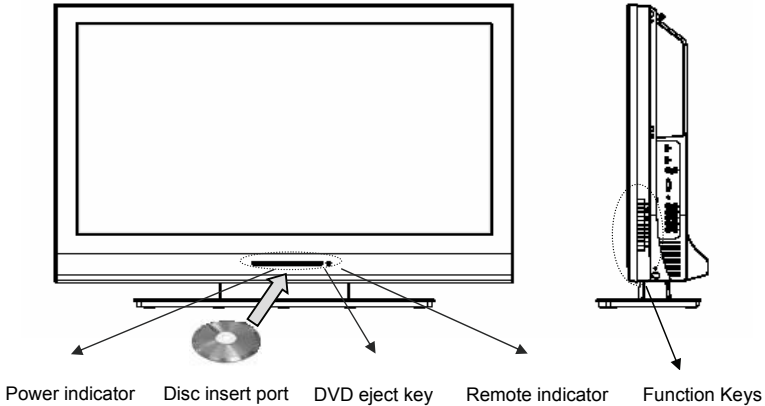

### FUNCTION KEYS

1. **MENU** : Display the main menu. When OSD is appeared, press the button to select or access the sub-menu.
2. **VOLUME (+ / -)** : Increase/decrease the volume or be the left/right arrow button for menu.
3. **CHANNEL (+ / -)** : Change the channel or be the up/down arrow button for menu.
4. **SOURCE** : Select the input source ( TV, S-Video1, S-Video2, Video 1, Video 2 , YPbPr 1 , YPbPr 2 , HDMI1, HDMI2, PC ).
5. **▶|| PLAY/PAUSE** : Control the DVD player to play or pause.
6. **◀◀ Backward/Previous Chapter(press and hold for 3 secs)** : Reverse or back to previous section of DVD.
7. **▶▶ FORWARD/Next Chapter(press and hold for 3secs)** : Forward or go to next section of DVD
8. **■ STOP** : Stop playing DVD
9. **⏻ POWER** : Turn the LCD-TV on or off.

**REMOTE SENSOR WINDOW** : aim the remote control towards this spot on the TV.

**POWER INDICATOR** : BLUE LIGHT — power on

AMBER LIGHT — power sleep

EXTINGUISHED — power off

**DVD EJECT KEY** : Inject the disc into the disc slot and eject the DVD disc.

---

**NOTE 1** : These buttons control the basic features of your TV, including the on-screen menu. To use advanced features, you must use the remote control.

**NOTE 2** : The picture of LCD TV display is for reference only.

---

## Side Panel Views

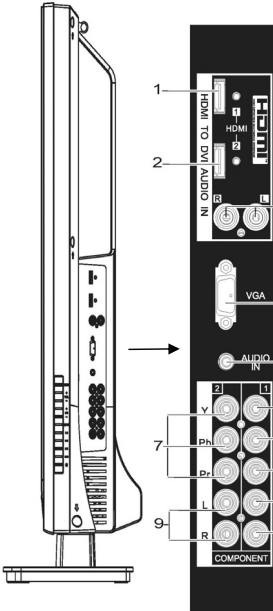

1. HDMI1 input  
Connect to an external video device such as HD digital cable/satellite receiver, HD STB, Media center PC, or DVD player
2. HDMI2 input
3. HDMI Audio input(R/L)  
Connect the audio input if you using a DVI-to-HDMI converter.
4. VGA  
Using a 15-pin VGA cable, connect to a computer.
5. VGA Audio in  
Connect to the audio out(Green) from a computer.
6. YPbPr1 input
7. YPbPr2 input  
Connect an external video device with component output to this jack.
8. YPbPr1 Audio1 input(L/R)
9. YPbPr2 Audio2 input(L/R)  
Connect an external audio source to this jack.

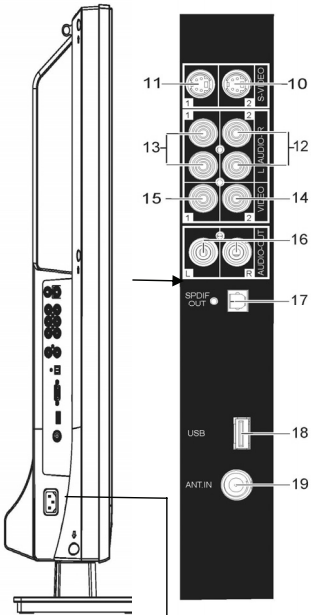

10. S-Video2 input
11. S-Video1 input  
Connect to a legacy video device such as a VCR or video game system.
12. Video2 & S-Video2 Audio input  
Connect an external audio source to this jack.
13. Video1 & S-Video1 Audio input  
Connect an external audio source to this jack.
14. Video2 input
15. Video1 input  
Connect the Composite video to a legacy video such as a VCR or video game system.
16. Audio output(R/L)  
Connect this output to an external stereo audio amplifier, receiver or surround sound processor with R/L audio inputs.
17. SPDIF output(Optical)  
Connect this output to an external stereo audio amplifier, receiver or surround sound processor with SPDIF optical input.
18. USB  
Factory service port
19. ANT.(RF input)  
Connect the LCD TV to an over-the-air antenna or cable service to view NTSC and ATSC(HDTV) content.

# Accessories



User's Manual



Remote Control & Batteries



Power Cord

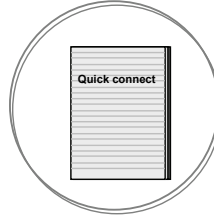

Quick Connect Guide



Warranty Card

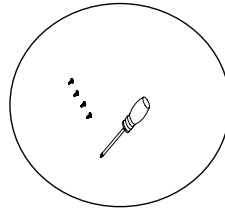

Screw driver & Screws x4(base)

# Remote Control

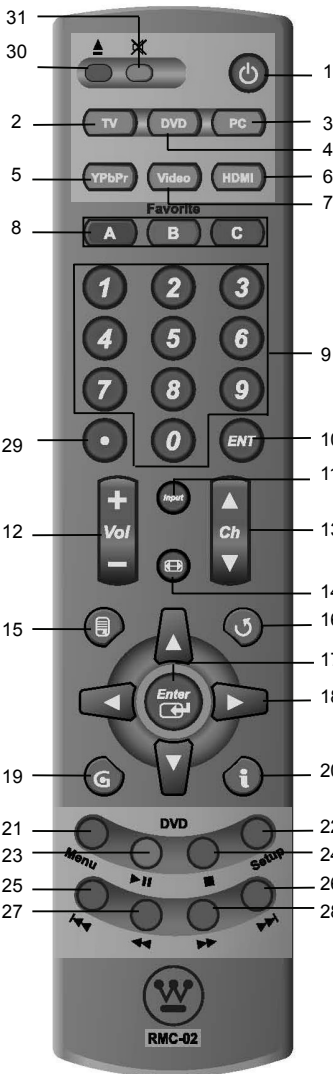

<b>1</b>	<b>Power</b>
	Switch TV power on/off.
<b>2</b>	<b>TV</b>
	Switch to TV
<b>3</b>	<b>PC</b>
	Switch to PC
<b>4</b>	<b>DVD</b>
	Switch to DVD
<b>5</b>	<b>YPbPr</b>
	Switch to YPbPr
<b>6</b>	<b>HDMI</b>
	Switch to HDMI
<b>7</b>	<b>Video</b>
	Switch to all video source
<b>8</b>	<b>Favorite</b>
	Select, remove or add your favorite channel. Press Favorite(A, B, C)key to access favorite list. Use arrow keys and enter key to select, add or remove the channel from favorite list.
<b>9</b>	<b>Channel number keys</b>
	Select specific channel.
<b>10</b>	<b>Enter</b>
	Execute a command.
<b>11</b>	<b>Input</b>
	Select input source.
<b>12</b>	<b>VOL +/-</b>
	Volume Up/Down adjustment.
<b>13</b>	<b>CH +/-</b>
	TV channel Up/Down adjustment.
<b>14</b>	<b>Screen Fit</b>
	Select video display format "Standard" or "Fill".
<b>15</b>	<b>Menu</b>
	Display the User setup menu.
<b>16</b>	<b>Return</b>
	Switch to previous TV channel or previous video input
<b>17</b>	<b>Enter</b>
	Execute a command.
<b>18</b>	<b>▲/▼/◀/▶</b>
	OSD manual control(▲/▼:TV channel Up/Down;◀/▶:Volume Up/Down)

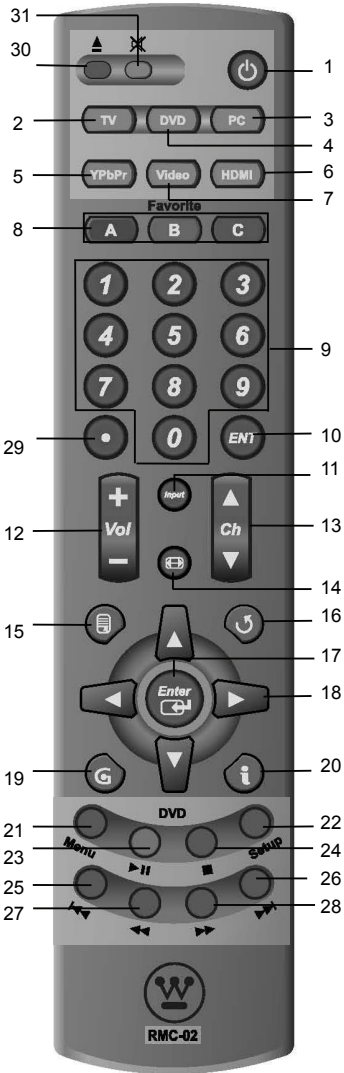

<b>19</b>	<b>Guide</b>
	Broadcast program information.
<b>20</b>	<b>Info.</b>
	Display the source and channel information.
<b>21</b>	<b>DVD Menu</b>
	Press to enter DVD Menu.
<b>22</b>	<b>Setup</b>
	Press to enter DVD Menu setup.
<b>23</b>	<b>Play/Pause</b>
	The play/pause function of DVD.
<b>24</b>	<b>Stop</b>
	The stop function of DVD.
<b>25</b>	<b>Previous section</b>
	Press to the previous section.
<b>26</b>	<b>Next section</b>
	Press to the next section.
<b>27</b>	<b>Backward</b>
	Backward for DVD.
<b>28</b>	<b>Forward</b>
	Forward for DVD.
<b>29</b>	<b>Dot button(NOTES)</b>
	Quicker access to all the available virtual channels
<b>30</b>	<b>Eject</b>
	DVD eject
<b>31</b>	<b>Mute</b>
	Turn the sound on/off.

## NOTES

- **Dot** : The Dot Drop List is menu list of all the virtual channels available on the current physical channel for the user to select. The user can utilize this function for quicker access to all the available virtual channels instead of channeling through each channel.

Key command	Function
Dot	Open dot list menu
Up	Move point to previous virtual channel
Down	Move point to next virtual channel
Left	Close dot list menu
Enter	Select and change current channel to points' channel

## INSTALLATION AND FUNCTION ADJUSTMENT

### Installation

#### 1. Insert Batteries into Remote Control

- 1) Remove the battery cover.
- 2) Insert two size AAA batteries corresponding to (+) and (-) marks on the battery compartment.

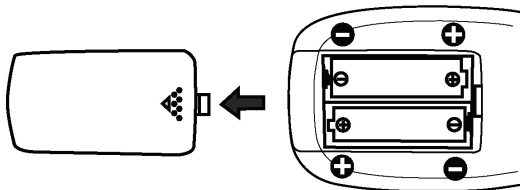

### CAUTION

- Only use AAA batteries.
- Do not mix new and old batteries. This may result in cracking or leakage, which may pose a fire risk or lead to personal injury.
- Insert batteries according to (+) and (-) markings. Inserting the batteries incorrectly may result in cracking or leakage, which may pose a fire risk or lead to personal injury.
- Dispose of used batteries in accordance with local laws and regulations.
- Keep batteries away from children and pets.
- When the remote control will not be used for an extended period, remove the batteries.

## 2. Connections

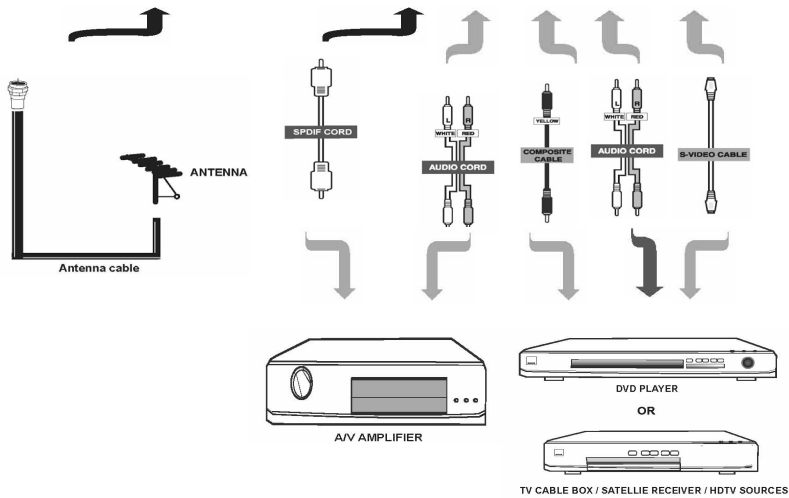
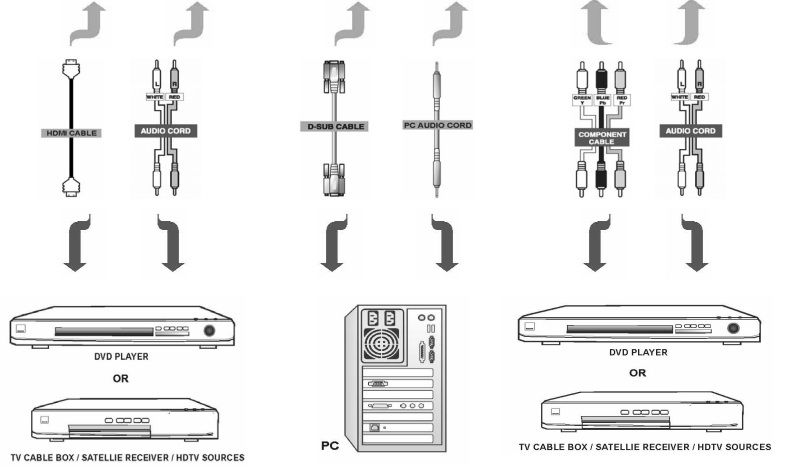



### **3. Connect power cables**

Connect the power cord to the LCD TV then to a proper AC outlet.

**IMPORTANT:** The power input voltage for TV is 120Vac, before beginning; make sure all devices are turned off.

### **4. Turn Power On**

Press the power button on the right side of the LCD TV, or press the power (Red) button on the remote control.

### **5. Select input source for the LCD TV using the OSD menu or remote control direct select buttons**

### **6. If connecting to Antenna, Cable or other RF source on TV inputs:**

See page 19 to scan and edit available channels.

### **7. If connecting to a PC(VGA):**

For the best picture quality, set the timing of your computer to 1366 x 768 at 60Hz.

Refer to the graphic card's user guide of your computer to set this timing.

## How to remove the BASE

- Carefully place the TV face down on a soft clean surface.
- Remove the four screws underneath the BASE.  
(See picture below)
- Pull out the BASE from the TV.

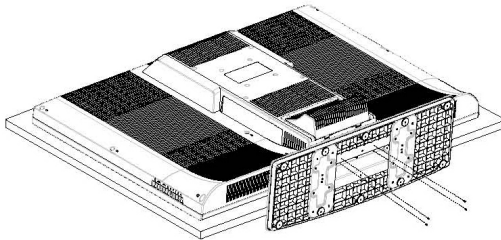
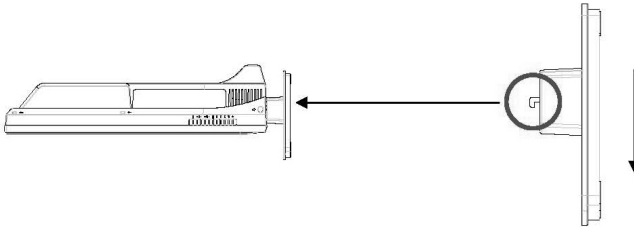
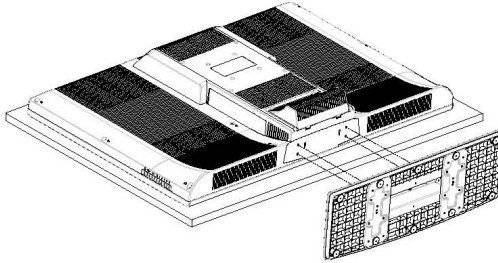

## **Function adjustment**

There are four main Setup Menus; these are Settings, Channels, Locks and Guide. All the functions can be adjusted either by the remote control or by using the control keys on the LCD TV's right side.

### **Viewing OSD Menu**

To display the main menu, press the Menu button on the right side of front control keys of the LCD TV or the MENU key on the remote control. Press arrow keys to select desired OSD menu and Enter key to select desired setting.

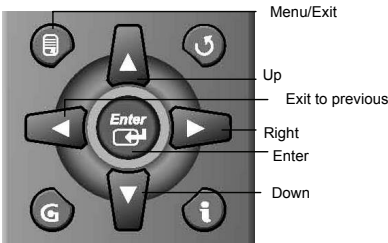

### **Video**



## Video settings:

Press arrow keys to select or adjust your favorite picture settings. DONE button to close picture setting menu.



## Screen Fit:

Adjust your TV screen to handle different picture formats.

Standard/Fill/Overscan



## Color Temp.:

Press arrow keys to select or adjust your preferred color temperature settings.

Cool/Neutral/Warm/User



## 3D Comb Filter:

Press arrow keys to select or adjust your preferred settings.

Off/Low/Medium/High



## Temporal NR:

Press arrow keys to select or adjust your preferred settings.

Off/Low/Medium/High



## Audio Setting



### Bass, Treble & Balance

Use arrow keys to adjust the bass, treble and balance.



### Optical Out

Select AC3/PCM



### Analog Preference

Select an analog audio preference if TV signal is analog.

Mono/Stereo/SAP



### Digital Preference

Select language preference for digital channels.

English/French/Spanish



## Settings



## Close Captions

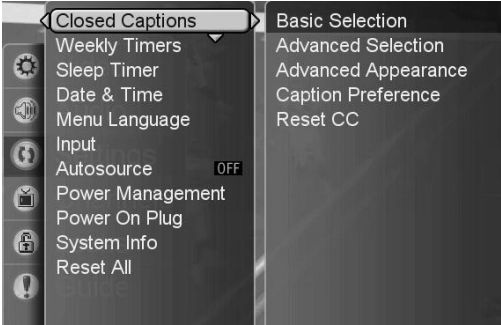

### Basic Selection

Choose the type of closed caption settings to use for programs broadcast with basic caption.

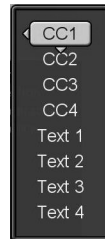

### Advanced Selection

Use arrow keys to adjust closed caption appearance such as font and size, each change can be previewed on bottom of menu.



### Caption Preference

Select Always Basic/Always Advanced/Automatic.

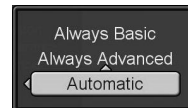

## Timers

Select automatic power-on time.

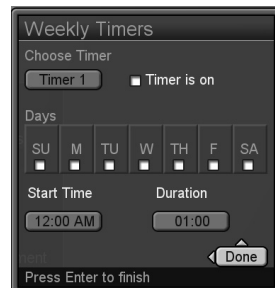

## Date & Time

Set Date & Time.

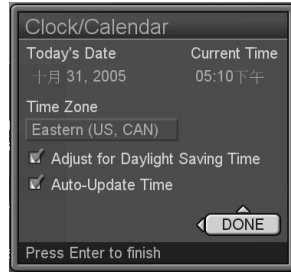

## Menu Language

Use arrow keys to adjust Menu Language



## Input

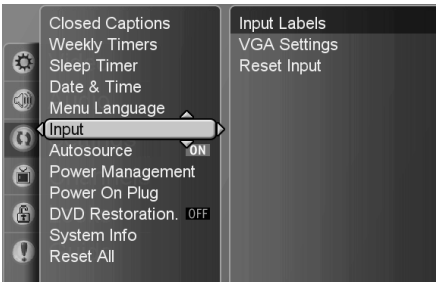

## Autosource™

Autosource™ will detect a new incoming signal and automatically switch the input source to the connection of the new source's device.



## Power Management

Set TV power saving modes(Normal/quick boot-up time, but large power consumption; Energy saving/longer boot-up time, but small power consumption.)

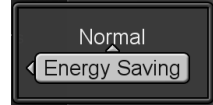

## Power On Plug

Set TV power on memory when un-plug power cord and re-plug it.(ON/automatic power-on memory; OFF/no automatic power-on)

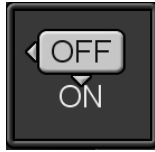

## System Info

Display important system info, you may need the information when calling customer service or troubleshooting such as firmware version and micro version. Press DONE button or arrow key to previous menu.

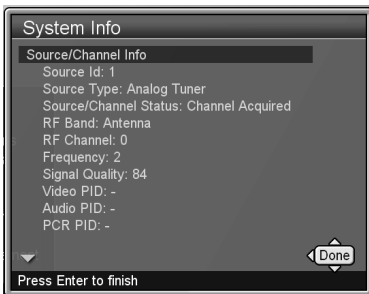



## RESET ALL

Reset all settings back to factory defaults. Reset will delete all settings you have made including channel list.



## Channels



### Master Channel list

To display which channels have been scanned.



## Scan Channels

To auto scan current available channels by using “Antenna or cable” scan.

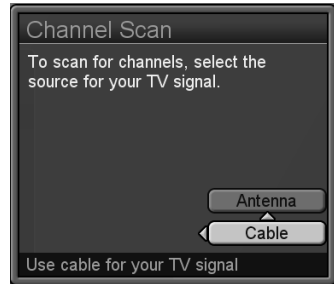

## Favorites

To display which channels have been set for Favorites.



## Find Channel

Enter channel number via number key then press DONE button to find a channel. You may be required to enter four digits pin number if pin number was set before.

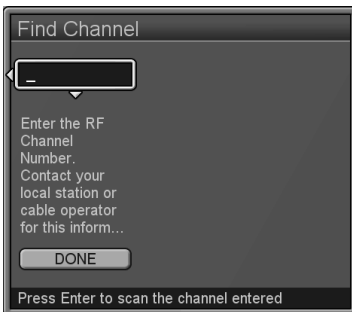

## Channel Name Edit

Edit the channel name in channel list. Enter the edited channel, press “enter” button of remote control, shows “Change name” menu. You can compile the name you like, then press “Done” button, the edition is to be finished.



## Locks

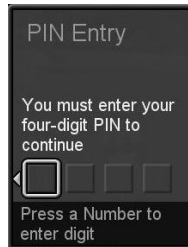

Lock feature prevents viewers from watching programs that are not age-appropriate, such as programs containing violence or adult language.

The pin number is required when you want to enter Locks menu, just use the remote control to key in your pin number. The factory default pin number is 0000.

## Rating Locks

Select which USA or Canada rating you want to set.\_

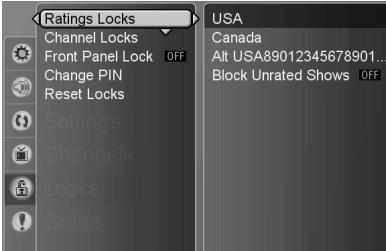

### USA TV Rating

- TV Y All children
- TV Y7 For older children
- TV G General audience
- TV PG Parental guidance suggested
- TV 14 Parental strongly cautioned
- TV MA Mature audience only

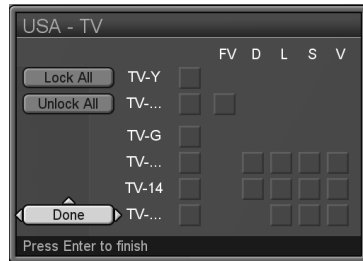

### USA Movie Rating

- G General audience
- PG Parental guidance suggested
- PG-13 Parental strongly cautioned
- R Restricted
- NC 17 No on 17 and under admitted
- X Adult audience only

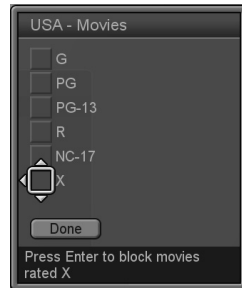

### Canada-French

- G General programming, suitable for all audience
- 8 ans+ Children eight years and older
- 13 ans+ Viewers 13 year and older
- 16 ans+ Viewers 16 year and older
- 18 ans+ Adult programming



## Canada-English

C	Children
C8+	Children eight years and older
G	General programming, suitable for all audience
PG	Parental guidance
14+	Viewers 14 year and older
18+	Adult programming



## Channel Locks

To set which channels are locked, use arrow keys to lock one or more channels. Select button on menu to lock and unlock channels.



## Front Panel Locks

Press Enter to enable or disables the Front Panel buttons.

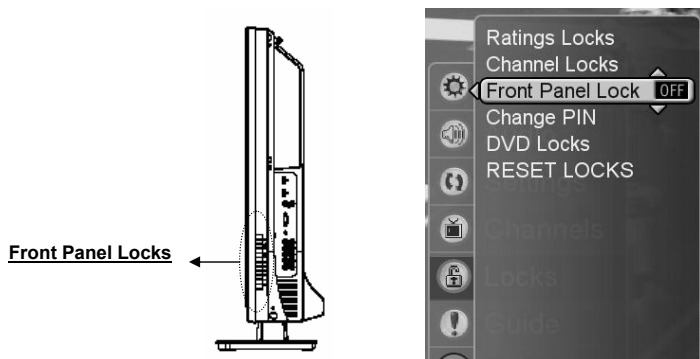

## Chang PIN

Change and set up new PIN, press number keys to enter old PIN and new PIN, the must be four digits.



## DVD Locks

Set up the DVD Rating Locks.



## RESET LOCKS

Press Reset button to reset all channel and rating locks.



## Guide

Show program information for the current channel, such as signal strength, resolution, channel number, V-chip, CC, and Program Title.



## DVD Menu



## Down Mix

Set the DVD Down Mix to Stereo or



LT/RT.



## Repeat

Press ENTER to scroll repeat option: CHAPTER, TITLE, ALL.



## Demo Mode

Press select to set the DVD demo mode ON/OFF.

ON : Repeat playback

OFF : Turn off repeat playback

## Subtitle

Press select to set the DVD subtitle function. (only available for DVD)



## Auto Wake

Press select to set the Auto Wake ON/OFF.

ON : Turn on auto wake function.

OFF : Turn off auto wake function.





## Audio Select

To select Audio language. (only available for DVD)



## Reset DVD

Reset DVD to factory settings, clearing any adjustments you have made.



# TROUBLESHOOTING

## There is no picture or sound.

---

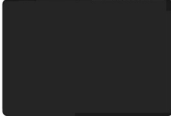

- Make sure the AC adapter is connected.
- Verify that there is a valid source signal.
- Make sure the correct input mode is selected.

## There is no picture from AV.

---

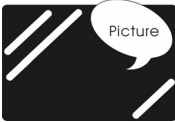

- Make sure the BRIGHTNESS is properly adjusted.
- The florescent lamp may have reached the end of its life. Contact an authorized service center.
- Make sure the video source is plugged into the composite video-in port.

## There is no sound.

---



- Make sure the volume is not set to minimum.
- Make sure the sound is not muted

## There is no picture or sound, just noise.

---



- The source signal may be weak.
- Your provider may be experiencing difficulties.
- Check your input connections.

## Picture is not clear.

---



- The source signal may be weak.
- The provider may be experiencing difficulties.
- Check input connections.

### Picture is light or improperly tinted.

---



- Check the Hue, Saturation and Color adjustments.
- Reset the TV to the factory default settings.

### The picture is too dark.

---



- Select a different Video Preset mode.
- Check the Brightness of Picture Settings.
- The fluorescent lamp may have reached the end of its life. Contact an authorized service center.

### Remote control does not work.

---



- Install new batteries.
- Make sure the remote sensor window isn't blocked.
- Make sure the system is in the right mode (TV / VCR / CBL / AUX)

### There are stripes on the screen or colors fade.

---



- There may be interference from other appliances.
- There may be interference between the video source cable and the power cable.
- Make sure the power and video cables are not touching. Check the Hue, Saturation and Color adjustments

---

**The picture is not sharp.**

---



- The signal source may be weak.
- The provider may be experiencing difficulties.
- Check input connections.
- Check the Sharpness of Picture Settings.

---

**The picture moves.**

---



- The source signal may be weak.
- The provider may be experiencing difficulties.
- Check input connections.

---

**The picture is doubled or tripled.**

---



- The source signal may be weak.
- Check input connections.

---

**The picture is spotted.**

---



- There may be interference from other appliances nearby or around the LCD TV.

# PC INPUT PRESET TIMMING TABLE

## PC / Timing Table

No.	Mode Name Resolution	H.Freq. V.Fre.	H. Polarity V. Polarity	Pixel CLK (MHz)	Hor. Total CLK No.	Hor. Display CLK No.	Hor. Bck Porch CLK No.	Hor. Syth CLK No.	Vert. Total Line No.	Vert. Display Line No.	Vert. Bak Porch Line No.	Vert. Syc Width Line No.
1	VGA 70Hz 720*400	31.469 70.087	- +	28.322	900	720	54	108	449	400	35	2
2	VGA 60Hz 640*480	31.469 59.941	- -	25.175	800	640	48	96	525	480	33	2
3	VGA 67Hz 640*480	35.00 66.667	- -	30.24	864	640	96	64	525	480	39	3
4	VGA 72Hz 640*480	37.861 72.809	- -	31.5	832	640	120	40	520	480	20	3
5	VGA 75Hz 640*480	37.5 75.0	- -	31.5	840	640	120	64	500	480	16	3
6	SVGA 56Hz 800*600	35.156 56.25	+ +	36.0	1024	800	128	72	625	600	22	2
7	SVGA 60Hz 800*600	37.879 60.317	+ +	40.0	1056	800	88	128	628	600	23	4
8	SVGA 72Hz 800*600	48.077 72.188	+ +	50.0	1040	800	64	120	666	600	23	6
9	SVGA 75Hz 800*600	46.875 75.0	+ +	49.5	1056	800	160	80	625	600	21	3
10	XGA 60Hz 1024*768	48.363 60.004	- -	65.0	1344	1024	160	136	806	768	29	6
11	XGA 70Hz 1024*768	56.476 70.069	- -	75.0	1328	1024	144	136	806	768	29	6
12	XGA 75Hz 1024*768	60.023 75.029	+ +	78.75	1312	1024	176	96	800	768	28	3
13	60Hz 1280*720	44.76 60.0	- +	74.481	1664	1280	192	136	746	720	22	3
14	60Hz 1280*800	49.68 60.0	- +	83.462	1680	1280	200	136	828	800	24	3
15	60Hz 1360*768	47.368 59.959	+ -	72.0	1520	1360	80	32	790	768	15	5

\* The resolution and the frequencies are displayed on the screen may not exactly same as this list.

# PRODUCT SPECIFICATION

ITEMS		LCD - TV	
<b>Panel</b>	Screen Size	40" LCD Panel	
	Aspect Ratio	16 : 9	
	Resolution	1366 x 768	
	Display colors	16.7M colors	
	Viewing Angle (CR>10)	178° Hor. / 178° Ver.	
<b>TV Function</b>	Broadcasting System	Analog : NTSC M / N	Digital : ATSC/Clear QAM
	Receiving Channel	Analog : PLL181Ch., CATV 125Ch	Digital : 54M Hz~864M Hz
	Sound System	Analog : Multi-channel TV Sound	Digital : Multi-Track Sound
	Resolution	Analog : 480i	Digital : 1080i, 720p,480p, 480i
	Data Broadcasting	Close Caption , V - Chip	
<b>Video Input</b>	Composite Signal	CVBS	x 2
	Y, C Signal	S-Video	x 2
	Component Signal	Y Pb Pr	x 2 (720P / 1080i , HDTV ready )
<b>PC Input</b>	HDMI Connection	HDMI x 2	
	VGA Connection	D-Sub 15 pin	
	Scanning Frequency	$f_{H} = 31.5 \sim 60\text{KHz}$ / $f_{V} = 56 \sim 75\text{Hz}$	
<b>Audio Input</b>	Audio 1	Composite	
		S - Video	
	Audio 2	Component	
	Audio 3	HDMI to DVI & PC jack in	
<b>Audio Output</b>	Speaker ( build-in)	10W + 10W (Average)	
	RCA Out	Left / Right	
	Digital Audio Out	SPDIF (DTV) .	
<b>Feature</b>	Function Keys	Power , Source , Menu , Up/Down(Channel) , +/--(Volume), Play/ Pause, Backward / Previous Chapter, Forward / Next Chapter, STOP	
	Video Performance	3D Comb-filter , 3D De-interlace , Aspect Ratio Control (ARC) , Auto Picture Control, Noise Reduction	
	Other Control	Sleep Timer, Timer On, Timer Off	
<b>Power</b>	Power Supply	AC 100V ~ 240V , 50 / 60Hz	
	Power Consumption	< 200 W	
<b>Dimension</b>	W x H x D	988 mm * 726 mm * 175 mm	
<b>Weight (net)</b>	Without Accessories	23 kg	





[www.wde.com](http://www.wde.com)